

# USER MANUAL

## uFlamer Gasboom

V1.0  
2023/05/18

**SHOWVEN®**



**SHOWVEN Technologies Co., Ltd**

Thanks for choosing SHOWVEN Flame system, we wish it will bring you lots of exciting moments. Please read the following user's manual and related product installation guide carefully before operating this system.

## **▲ Safety Instructions**

### **1. Safety icons explanation**

Safety instructions warn of hazards when handling equipment and provide information on how to avoid those hazards. They are classified according to the severity of the hazard and are divided into the following groups. Please do follow all safety instructions in this document!

**DANGER:** Indicates a hazardous situation that, if not avoided, will result in death or serious injury. (This signal word is limited to the most extreme situations)

**WARNING:** Indicates a hazardous situation that, if not avoided, could result in serious injury

**CAUTION:** Indicates a hazardous situation that, if not avoided, could result in minor or moderate injury.

**NOTICE:** Provide additional or supplementary information.

### **2. General Safety Instructions**

- ⚠ Unauthorized repair are prohibited, it may cause serious incident.
- ⚠ Make sure power supply is consistent with the rated voltage of the equipment, and the socket must be well grounded. Unplug and turn off the machine when not in use.
- ⚠ Please connect DMX cable before power on uFlamer Gasboom, and ensure that the communication command is disabled, and the safety switch of the device is under test mode.
- ⚠ After turning on the device, no person is allowed to stay in the danger area. Ensure all persons that are part of the show are informed about the safety distance, risks and functions of the device.
- ⚠ Always have a CO<sub>2</sub> fire extinguisher and an extinguishing blanket in case of need.
- ⚠ If there is any doubt as to the safety operation of the device in any circumstances, the device should be taken out of service immediately. Be sure the device is in good operating condition before use. If it fails to fire correctly, immediately shut down and check it accordingly. Any questions please always contact SHOWVEN (info@showven.cn) for help.
- ⚠ Be sure to use high quality flame fluid ISOPAR L/M, otherwise, it easily leads to failure or danger. Be careful when refilling the flame fluid tank. Please keep flame fluid away from heat source, sparks, fire or other possibility of ignition. Do not smoke!
- ⚠ The operator responsible for the control of the flame system must always have a clear view of the device, so that he/she can stop the show immediately when there is danger. The main AC power switch should be near the operator. So that the operator can turn off the power of all devices in case of abnormal.
- ⚠ The device shall not be altered and applied to other uses.

### **3. Disclaimers:**

SHOWVEN technologies Co., Ltd excludes liability for unsafe situations, accidents and damages resulting from:

1. Ignoring warnings or regulations as shown on product manual or this manual.
2. Use for other applications or circumstances other than those indicated herein.
3. Changes to the device, including use of non-original spare parts, lack of maintenance etc.
4. Dismantling device without authorization from SHOWVEN.
5. Use of this machine by unqualified or untrained personnel.
6. Improper use of machine.

## Warning:

A dry powder fire extinguisher, a carbon dioxide fire extinguisher and a fire blanket must be equipped next to the equipment. Someone must be on duty during operation. In case of fire accident, dry powder fire extinguisher can be used when the fire is large, and a carbon dioxide fire extinguisher can be used when the fire is small.

### ▲ Technical Specifications

- ∨ **Model:** uFlamer Gasboom
- ∨ **Housing Material:** 304 stainless steel
- ∨ **Dimension:** 320×310×325mm
- ∨ **Weight:** 13kg
- ∨ **Input:** AC100-240V, 50/60Hz
- ∨ **Work Power:** 200W
- ∨ **Usage in Rain:** Yes
- ∨ **Battery / Standby Time:** 4 \* 18650 cells, about 30h
- ∨ **Battery Charging:** Through power cable
- ∨ **Work Pressure Range:** 0-5Bar
- ∨ **Ignition:** Dual, high voltage electron ignition
- ∨ **Super Sensitive Flame Monitoring:** Yes
- ∨ **Solenoid Valves:** Dual, connect in series
- ∨ **Control:** DMX , 9-60V pyro signal, Wireless with Wireless DMX Receiver (5-PIN DMX IN with DC5V power supply)
- ∨ **DMX:** 3-pin and 5-pin DMX IN / OUT
- ∨ **E-Stop Interface:** Yes, can be connected in series
- ∨ **Effect Direction:** Vertical
- ∨ **Flame Height:** 2-8m (depends on nozzle type, firing duration, temperature etc.)
- ∨ **Firing Duration:** 0.1 – 10s adjustable
- ∨ **Firing Mode:** Standard mode, SFT mode
- ∨ **Fuel:** Propane or Butane
- ∨ **Cartridge Holder:** Twin cartridge holder with 2 shut-off valves and 2 non-return valves, support 250g, 330g and 450g bottle  
Quadruple cartridge holder with 4 shut-off valves and 4 non-return valves (optional), support 250g and 330g bottle.
- ∨ **Cartridge Interface:** 7/16" UNEF
- ∨ **Micro Filter:** Yes, installed between shut-off and non-return valves
- ∨ **Tip sensor:** Yes
- ∨ **Audio bracket fixing hole:** Yes (Inner hole diameter φ36MM, inner hole height 62MM)

## ▲ Structure

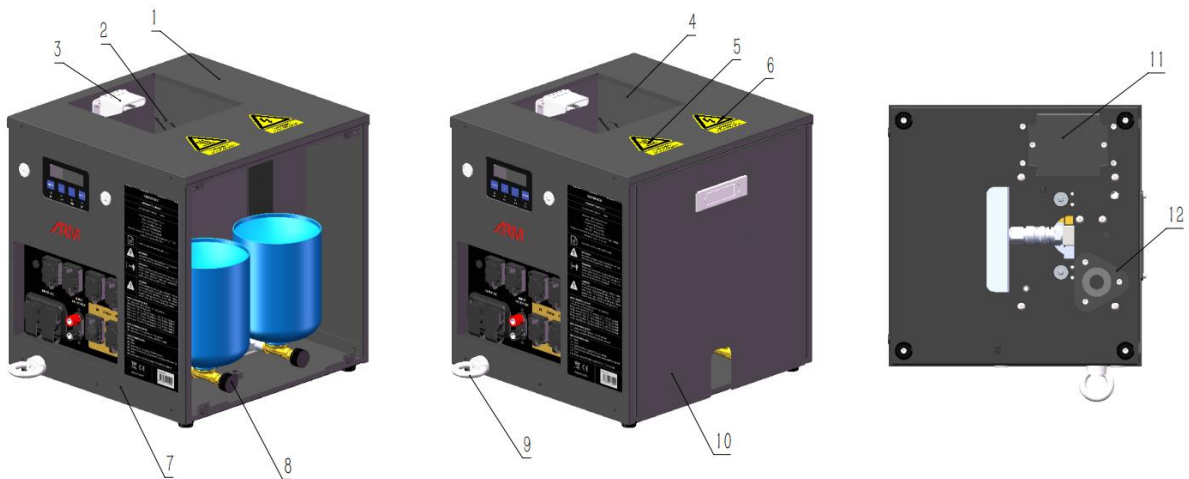

1. Top panel
2. Igniter (dual)
3. Flame detector
4. Fire box
5. Hot surface icon
6. High voltage icon
7. Rear panel
8. Cartridge holder
9. Safety loop
10. Side panel
11. Battery box
12. Audio bracket fixing hole

Cartridge holder for 2 (SFMET1063) support cartridge with outer diameter is less than or equal to  $\phi 110\text{mm}$ , and the height is less than 275mm.

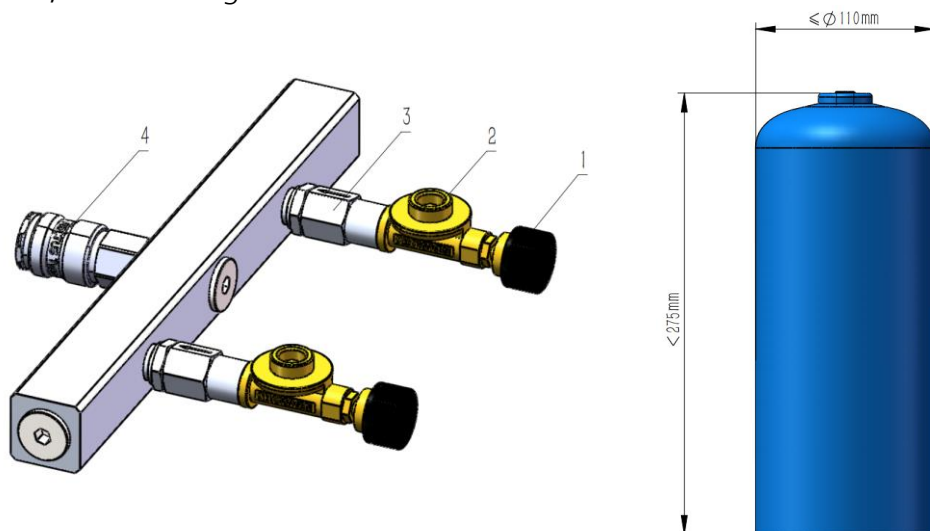

1. Shut-off valves switch
2. Cartridge Interface
3. non-return valve
4. Quick coupler

Cartridge holder for 4 (SFMET1108) support cartridge with outer diameter is less than or equal to  $\phi 66\text{mm}$ , and the height is less than 275mm.

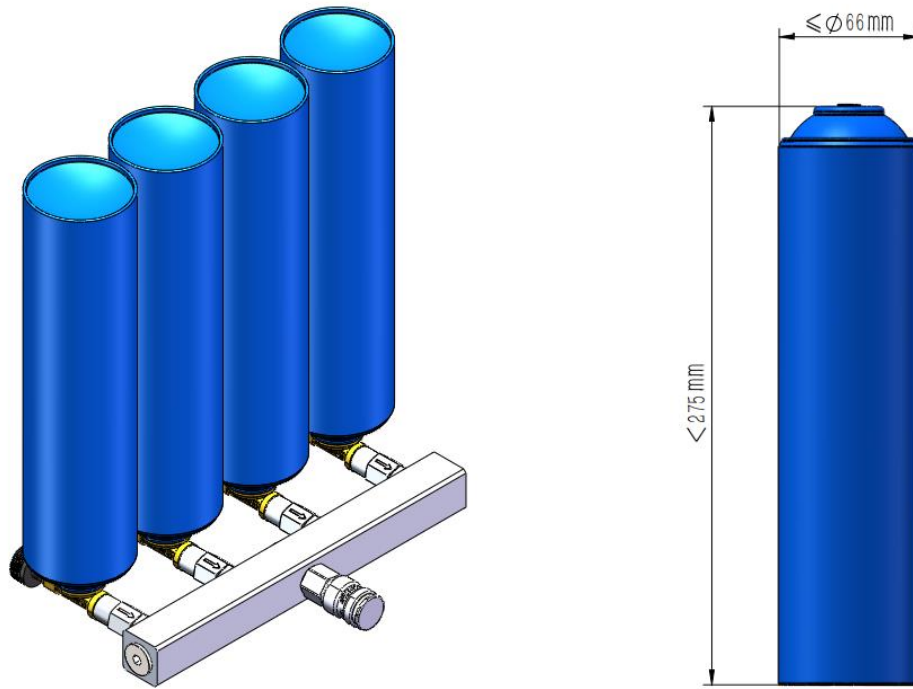
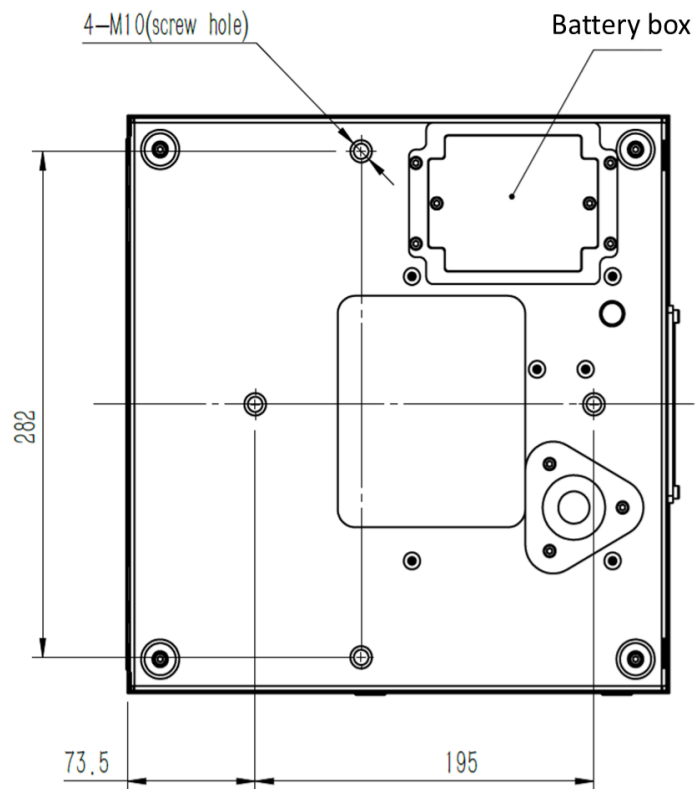
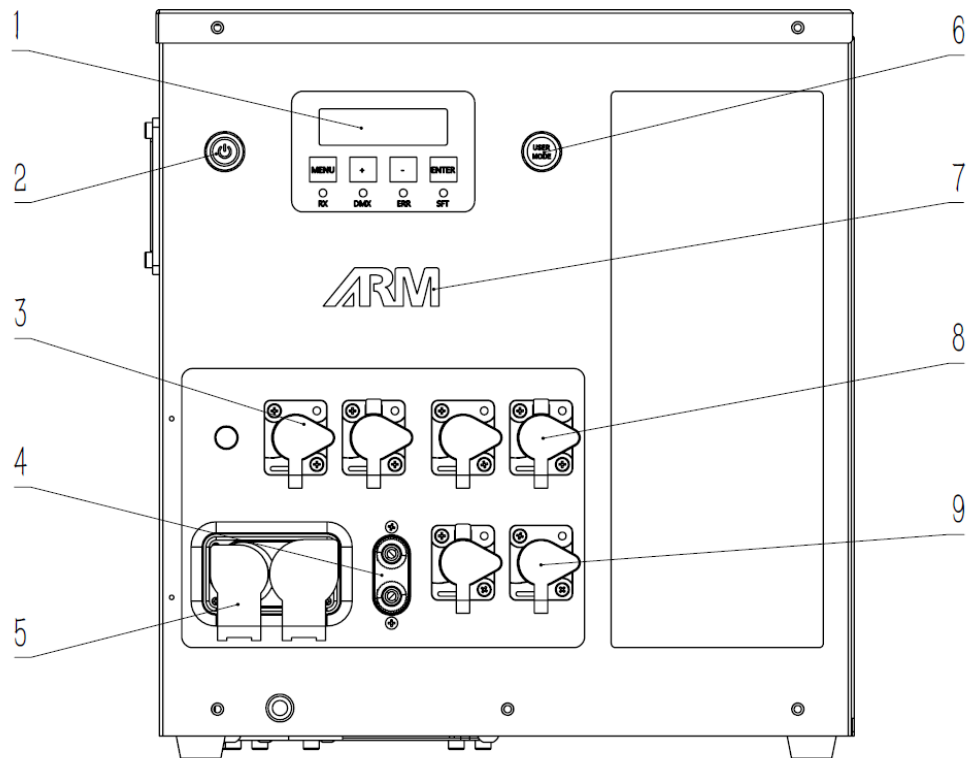

Diagram of bottom panel



## ▲ Rear Panel



1. LCD Screen
2. Power Switch (with Power indicator light)
3. 3-pin XLR IN/OUT
4. 9-60V pyro signal port
5. Power IN
6. Safety Lock Button (with safety mode indicator light)
7. ARM indicator light
8. 5-pin XLR IN/OUT (5-PIN XLR IN can charge for wireless DMX pen through pin1 and 4, pin4 with DC5V power supply)
9. E-stop interface

## ▲ Display and setting

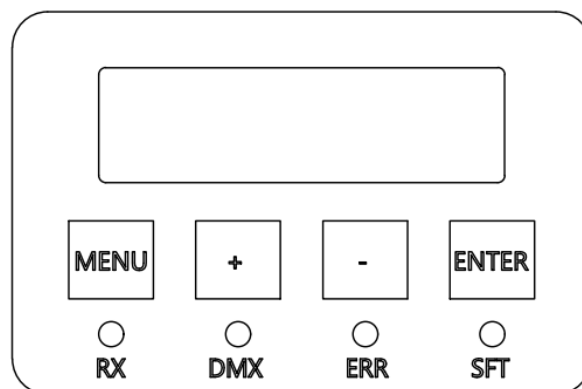

### 1. Display area

Indicator light	Explanation	ON	OFF	BLINK
RX	Power Input Indicator	AC Input	No AC Input	N/A
DMX	DMX signal	N/A	No DMX signal	DMX connected
ERR	Alert or Error message	Alert or Error	No	N/A
SFT	SFT mode indicator	SFT mode ready	SFT OFF	SFT not ready yet

## 2. Button functions

**MENU:** Switch interface to setup parameter;

**+:** Parameter Up

**-:** Parameter Down

**ENTER:** Confirm and save parameters (screen will flash once when parameters saved)

*Note: screen display will switch to main interface if there is no operation in 10s.*

## 3. ARM indicator light



Operators can enable/disable the arm indicator light by set the "ARM STATE" in Advanced menu. If "ARM STATE" is ON, there will be three status:

**ON:** no DMX signal

**OFF:** DMX signal input

**BLINK:** DMX armed or Ext Ignite in advanced menu is ON

## 4. Power and Safety Mode Indicator Light

**Power Indicator Light**

**Light ON:** Power ON

**Light OFF:** Power OFF

**Safety Mode Indicator Light**

**Light ON:** User Mode

**Light OFF:** Test Mode

## 5. Welcome interface

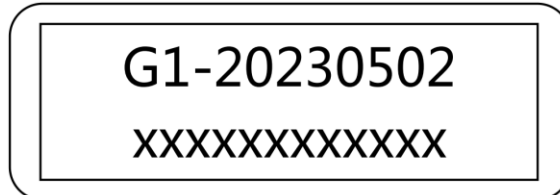

**First Line:** Product model and software version

**Second Line:** Equipment series number

## 6. Main interface

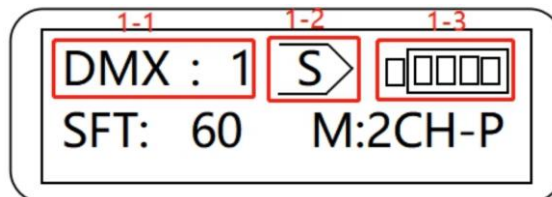

**First Line:**

**1-1:** DMX address (In 2CH-P mode, it will be displayed alternately with the safety channel address)

**1-2:** Flame monitoring icon. Icon occurs if firing successfully. (set "Flame Monitor" to ON in advanced menu, otherwise no such icon)

**1-3:** Battery Icon shows the battery status:

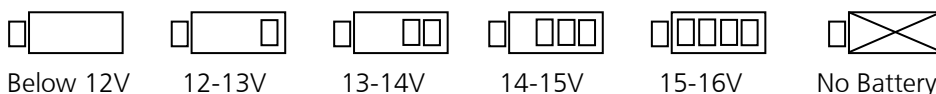

If the battery is flash means it is charging.

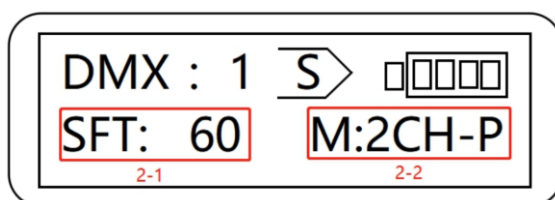

Second Line:

2-1: display SFT value under SFT mode, display "SFT:- -" in standard mode.

2-2: DMX channel mode (2CH-P, 6CH, 2CH-N), besides, it may also display alert or error message alternatively.

## 7. Alert Message

Alert Message	Why it appears	How to remove
E0 Test Mode	Safety Switch at TEST MODE	Switch to USER MODE
E0 Factory Mode	Factory mode	Switch to Normal mode
E4 Extignite ON	Ext Ignite ON	Set Ext Ignite to OFF

## 8. Error Message

Error Message	Why it appears	How to remove
E2 Sens Break	SFT sensor breakout	Connect SFT sensor
E3 VoltageErr	Battery voltage abnormal	Charge or replace new battery
E5 MissFire Exceeded	Consecutive ignition failures exceed the set value of "FI Moni Fail Num" in advanced interface	Restart the machine
E6 Tip Err	Machine slant over 45°, it stops running	Tip setting set to OFF, or horizontal install machine.
E7 SFT Exceeded	SFT value exceeds the set value	Need to check the SFT sensor
E8 SFT Err	Not reached setting value after turning ON SFT function for 5min	Need to check the coil for SFT function

## 9. Interface setup

For 6CH mode and 2CH-N mode

Menu	Range	Default	Explanation
Set DMX Address	1~512	1	DMX address setup

For 2CH-P mode

Menu	Range	Default	Explanation
Fire Address	1~512	1	Fire DMX address setup
Safety Address	1~512	2	Safety DMX address setup

## 10. Advanced Interface

Press and hold "MENU" for 3s enter advanced interface, press "MENU" to switch interface, press and hold "MENU" 3s can back to main interface.

Items	Contents	Default	Description
Drive Test	Igniter		Ignite 3 times, 1.5s per time with 0.5s interval
	Jet Valve 1		Jet valve open 3 times, 0.5s per time with 0.5s



	Jet Valve 2		interval
	ARM LED		ARM indicator light ON 3 times, 0.5s per time with 0.5s interval
	Fire Vol		Flame monitoring voltage
	ACDC Vol		Power supply voltage
	Batte Vol		Battery voltage
Ext Ignite	OFF / ON	OFF	Trigger through 9-60V pyro ignition signal
ExtIgnite Time	0.1s~9.9s	0.2s	Ext ignite duration, this menu appears only when Ext Ignite is ON.
语言 (Language)	English / Chinese	English	Language switch
Mode Select	Normal Mode / Factory Mode	Normal Mode	Factory mode is for test in factory only
Tip Setting	OFF / ON	ON	Turn ON/OFF tip over function
DMX Channel Mode	2CH Pro Mode /6CH Mode /2CH Normal Mode	2CH Pro Mode	DMX channel mode switch
Safety Level	76-120/ 102-153/ 127-178/ 153-204/ 178-229	102-153	Available only under 2CH-P mode. Safety channel DMX value within the set threshold range, firing enabled; outside the range, firing disabled.
DefaultParamete	ON/OFF	OFF	Reset default parameter settings
Flame Monitor	ON/OFF	OFF	Check the firing was success or not
Fl Moni Value	0.01V-3.30V	0.35V	Threshold value for a successful firing
Fl Moni Fai Num	0-10	2	Consecutive ignition failures setting
Flamepower Mode	Standard Mode /SFT Mode	Standard Mode	Standard mode, super flame mode
SFT Value	30-60	43	Appropriate SFT value can eliminate the flame tails after firing, high SFT value may cause poor ignition.
ARM State	ON/OFF	打开	ARM indicator light ON/OFF setting

### ▲ DMX CONTROL

uFlamer Gasboom with 3 different channel mode: 2CH-P, 2CH-N and 6CH.

2CH-P:

In this channel mode uFlamer Gasboom occupies 1 functional channel CH-F and 1 separate safety channel CH-S (this channel is independent from operational channel, can be shared with other machine).

Channel	Function	Value
CH-F	Firing	<b>0~110:</b> Firing OFF <b>111~255:</b> Firing ON
CH-S	Device enable / disable	<b>0~101 and 154~255:</b> Depressurize mode, disable device (Emergency STOP) <b>102~153:</b> Pressurize mode, enable device Above setting is take the default safety level (102-153) setting as an example, other safety level value setting please refer to advanced interface

2CH-N:

In this channel mode uFlamer Gasboom occupies 2 functional channels.

Channel	Function	Value
CH-1	Firing	0~110: Firing OFF 111~255: Firing ON
CH-2	Firing Enable / Disable	0~239: Firing Disable (Emergency STOP) 240~255: Firing Enable

6CH:

In this channel mode uFlamer Gasboom occupies 6 functional channel. This channel mode is designed to control the uFlamer together with CIRCLE FLAMER on our Host Controller.



Channel	Function	Value
CH1	-	-
CH2	-	-
CH3	Firing ON/OFF	0~253: Firing OFF 254~255: Firing ON
CH4	Firing Duration setup	0 and 255: permanent fire (2s is limit duration time) 1~254: 10~2540ms duration time (Manual firing duration = DMX Value * 10ms)
CH5	-	-
CH6	Firing Enable / Disable	0~49 and 201~255: Firing Disable (Emergency STOP) 50~200: Firing Enable

## ▲ Operation

### 1. Safety explanation







#### 1.1 Safety Icon

Please read safety explanation carefully before operating uFlamer Gasboom.

 <p><b>WARNING:</b> The firing box, ignition probes, flame detection cover and top cover are hot, do not touch.</p>		
 <p><b>WARNING:</b> High voltage between ignition probes during operation, do not touch.</p>		

#### 1.2 Device Label



<b>SHOWVEN®</b>	
<b>uFlamer® Gasboom</b>	
AC 100V-240V 50/60Hz 200W	
Showven Technologies Co., Ltd. Web: www.showven.cn E-mail: info@showven.cn Tel: +86-731-83833068 Add: No.1 Tengda Road, Liyang Economic & Technical Development Zone, 410300, Changsha, Hunan, P.R.China	
	Read the manual carefully before use.
	<b>WARNING</b> Hazardous voltage inside, please do not remove the cover unless by trained personnel.
	<b>WARNING</b> People and flammable materials should keep a certain safety distance around the machine and in the firing direction. Check user manual for detail safety distance information.
	<b>CAUTION</b> Before exchanging aerosol, gas cartridges / bottles or after each usage, please first shut off fuel supply, then empty the remaining fuel in the system (pipeline and gas hose) by activating the flamer several times until no flame is being generated.
<b>DMX CHANNELS (2CH-P)</b> CH-F: Ignition (0-110 no ignition, 111-255 ignition) CH-S: Safety channel (optional) Safety Level 76-120 (76-120 enabled, 0-75, 121-255 disabled) Safety Level 102-153 (102-153 enabled, 0-101, 154-255 disabled) Safety Level 127-178 (127-178 enabled, 0-126, 179-255 disabled) Safety Level 153-204 (153-204 enabled, 0-152, 205-255 disabled) Safety Level 178-229 (178-229 enabled, 0-177, 230-255 disabled)	
<b>DMX CHANNELS (2CH-N)</b> CH1: Ignition (0-110 no ignition, 111-255 ignition) CH2: Safety channel (0-239 disabled, 240-255 enabled)	
<b>DMX CHANNELS (6CH)</b> CH1: Blank CH2: Blank CH3: Ignition (0-253 no ignition, 254-255 ignition) CH4: Opening Time (0 and 255=permanent, Time[ms]=DMX value*10) CH5: Blank CH6: Safety channel (50-200 enabled, 0-49, 201-255 disabled)	
 MADE IN CHINA	 Serial Number 9 788087 049099

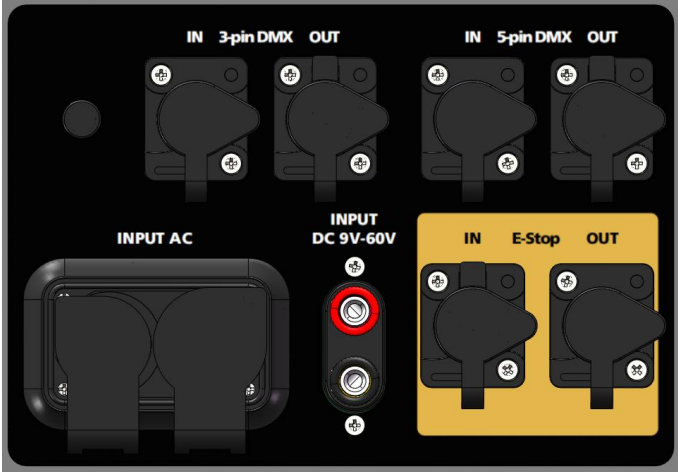

**NOTICE:**  
The yellow area is E-Stop interface. The device enabled only when there is E-Stop terminal or E-Stopper connected the E-stop IN interface.

### 1.3 E-Stop

The E-Stop interface is power cut-off interface, and the device can be powered on normally only after the interface is connected.

**E-Stop terminator (standard configuration, SFMET1107).**

Put the E-Stop terminal in the E-Stop IN interface.



### E-Stopper (optional, FPEST001).

E-Stopper connects with single unit of uFlamer Gasboom as below.

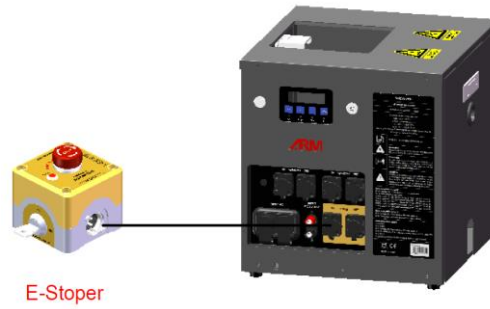

E-Stopper connects with multi units of uFlamer Gasboom in series as below:



**NOTICE:** E-Stopper can connect 24 units of uFlamer Gasboom in series maximum.

**NOTICE:** For more information about E-Stopper please check the E-Stopper manual.

### 1.4 Safety Distance

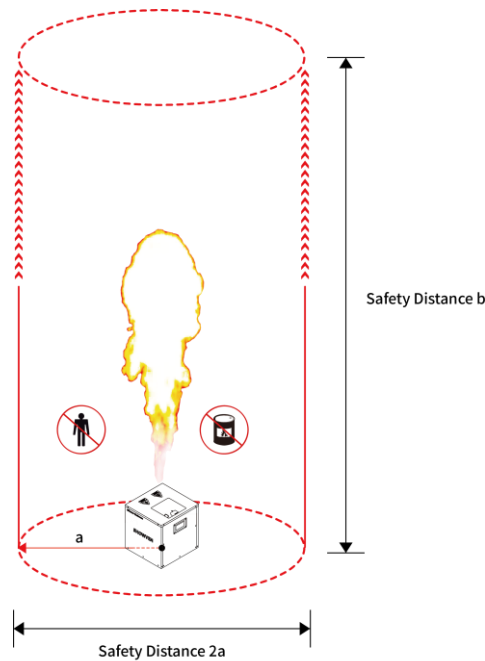

The uFlamer Gasboom safety isolation zone (show as below) is a cylindrical three-dimensional space with safety radius around machine (a) and safety distance at firing direction (b). For safety distance at firing direction equals to maximum firing height+2m.

No person and flammable materials are allowed to stay inside the safety isolation zone when flamer was armed. Unauthorized persons and objects are strictly prohibited from entering.

The safety distance a & b related with nozzle size, environment temperature, firing duration etc. We get below effect height and safety distance for your reference based on our test with two 450g gas cartridges and set firing duration at 0.2s. If necessary, please expand the safety distance according to the actual situation.

### Nozzle G16, G20 and G25

Nozzle Type	Temperature	-10~0°C	0~10°C	10~30°C	30~40°C
G16	Effect Height (m)	1.5~2.5	2.5~3.0	3.0~3.5	2.5~3.0
	Safety Radius a (m)	2	2.5	2.5	2.5
	Safety Distance b (m)	4.5	5.0	5.5	5.0
G20	Effect Height (m)	2.0~3.0	3.0~3.5	3.5~4.0	3.0~3.5
	Safety Radius a (m)	2.5	2.5	2.5	2.5
	Safety Distance b (m)	5.0	5.5	6.0	5.5
G25	Effect Height (m)	2.5~3.5	3.5~4.0	4.0~4.5	3.5~4.0
	Safety Radius a (m)	2.5	2.5	3.0	2.5
	Safety Distance b (m)	5.5	6.0	6.5	6.0

### Nozzle GA

Nozzle GA can be used with gas cartridge, and it is only suitable for 10°C~40°C.

Nozzle Type	Temperature	10~15°C	15~30°C	30~40°C
GA	Effect Height (m)	4.5~7.0	5.5~8.0	4.5~7.0
	Safety Distance a (m)	4.0	4.0	4.0
	Safety Distance b (m)	9.0	10.0	9.0

**WARNING:** Forbidden to use Nozzle GA with gas cartridge when temperature is lower than 10°C.

**CAUTION:** For angled installation, the safety distance both around machine and firing direction should shift accordingly.

## 2. Battery for uFlamer Gasboom

uFlamer Gasboom can be powered through 4 pcs of 18650 cells. New Gasboom come only with battery compartment, customer need to get 18650 cells locally. The battery installations are as below:

- Unscrew the screws of the battery box at the bottom panel as below.
- Install the battery in correct direction, pay attention to the positive and negative pole.
- Screw tight the battery box cover.

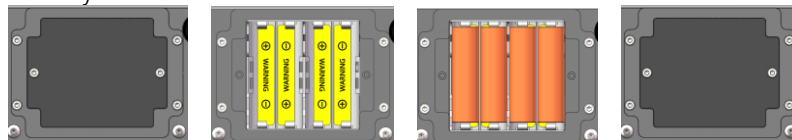

- Active 18650 battery by connect the machine with AC power. When there is battery icon show on LCD screen means 18650 cells was activated successfully.
- Charging: charging automatically when machine connected with AC power supply (no matter machine was powered on or not)

**NOTICE:** To avoid the damage of battery, charge the battery at least once per month.

**NOTICE:** 18650 battery activation is necessary whenever install the battery

**NOTICE:** SFT mode disabled under battery powered mode

## 3. Install gas cartridges for Gasboom

- a) Before install gas cartridges please confirm safety switch stays at TEST MODE. When safety button is pressed down, it is USER MODE; when it pops up, it is TEST MODE.
- b) Close the shut-off valves on cartridge holder. Rotate the knob clockwise to close the shut-off valve (when the black mark is totally hide inside then the shut-off valve is tightly closed).

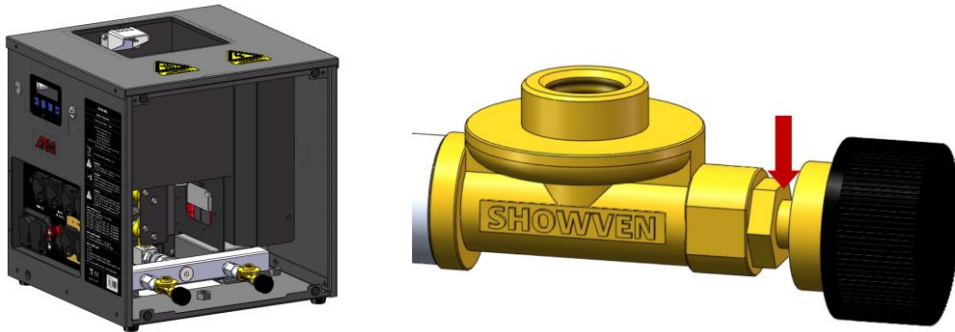

- c) Pull out the cartridge holder through the hole at the bottom of machine. The cartridge holder and machine are connected with quick coupler as below, pull out the quick coupler connection to disassemble the cartridge holder.

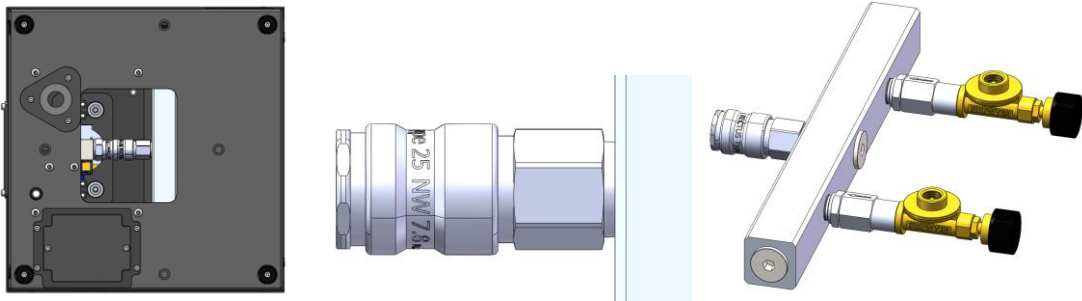

- d) Screw the gas cartridge to cartridge holder tightly.

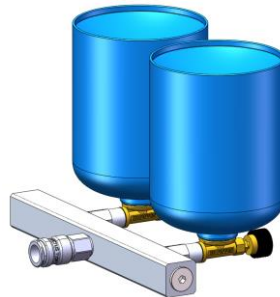

- e) Install cartridge holder with gas cartridge back to the machine, open the shut-off valve by rotate the knob anti-clockwise. Install the side panel.



#### 4. Install uFlamer Gasboom

- a) Horizontal installation is preferred for uFlamer Gasboom. If use built in gas cartridges, Gasboom with maximum tilt angle of 45° or -45°, and it can be angled to two directions as show in below picture. But the flame height will be affect in angled installation.

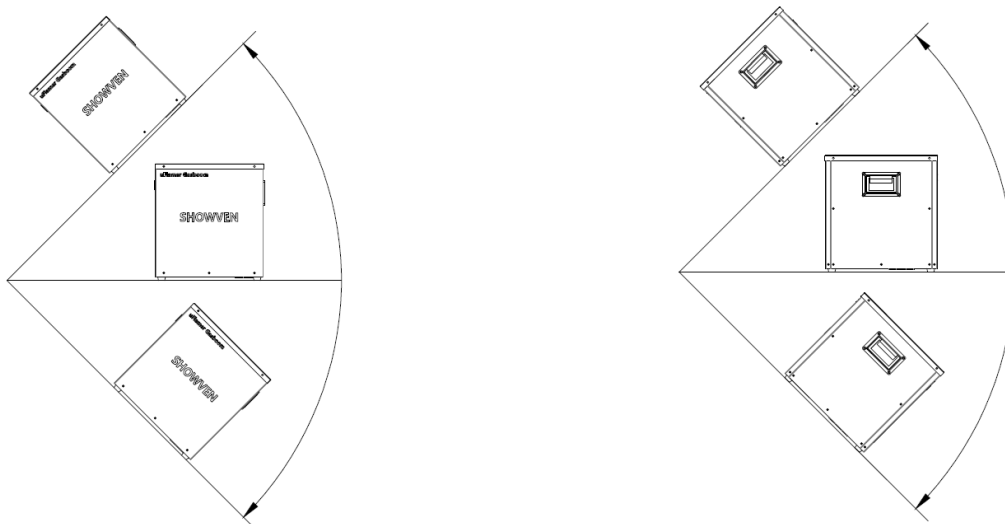

b) If Gasboom gas supply via hose connection from gas bottle, Gasboom can be installed in any direction even upside down. But the flame height will be affected in angled installation.

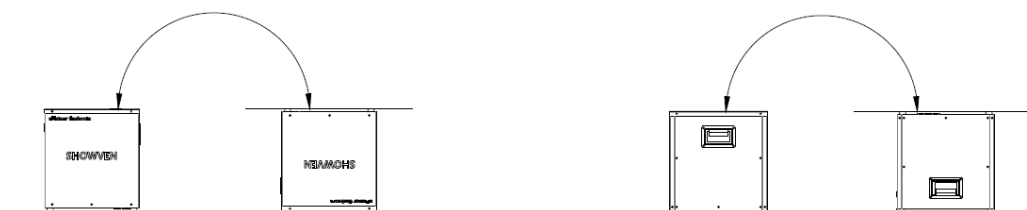

c) For truss installations always connect with safety rope to ensure extra safety. If there is any other national or regional guidelines please follow it accordingly.

d) Double confirm the machine was firmly installed.

**NOTICE:** For angled installation with angles  $>45^\circ$ , please turn off the TIP sensor.

## 5. Connecting uFlamer Gasboom

Make sure the DMX or pyro controller is disarmed or powered off during cable connection.

**If control by DMX controller, follow below steps:**

- Connect a DMX cable to the DMX IN socket of first unit of uFlamer Gasboom, another head of this DMX cable connect to DMX console (such as FXcommander). Make sure the DMX console is powered off.
- Connect a DMX cable to the DMX OUT socket of previous uFlamer Gasboom, and the other end to the DMX IN of next machine. Connect all devices in series in this way.
- Suggest to plug in a DMX terminator into the DMX OUT in last unit of machine to improve signal reliability. For distance  $>200\text{m}$  please use SHOWVEN DMX splitter 8 to amplify the signal.
- Connect a power cable to the POWER IN socket of uFlamer Gasboom. Connect the other end of power cable to the power source. Make sure power supply is consistent with the rated voltage of the equipment, and the socket must be well grounded.
- Each unit of uFlamer Gasboom can be connected to power supply directly. If connect machine in sequence, please connect a power link cable to the POWER OUT of previous machine, connect the other end of the power link cable to POWER IN of the next machine. Do not connect exceed units to a single electrical circuit.
- Connect machine with E-stop terminal or E-Stopper.
- Power on all uFlamer Gasboom. Check the safety button, double confirm it stays at "TEST MODE".

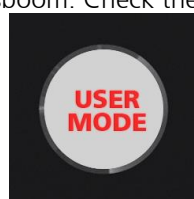

USER MODE

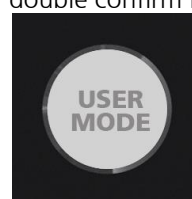

TEST MODE



- h) Assign DMX address for each unit of uFlamer Gasboom. If use SHOWVEN host controller or FXcommander to control the machine please allocate a unique DMX address for each unit of machine.

**If control by 9-60V pyro signal, follow below steps:**

- a) Connect a power cable to the POWER IN socket of uFlamer Gasboom. Connect the other end of power cable to the power source. Make sure power supply is consistent with the rated voltage of the equipment, and the socket must well grounded.
- b) Each unit of uFlamer Gasboom can be connected to power supply directly. If connect machine in sequence, please connect a power link cable to the POWER OUT of previous machine, connect the other end of the power link cable to POWER IN of the next machine. Do not connect exceed units to a single electrical circuit.
- c) Connect the power control cables to the 9-60V pyro signal connector on uFlamer Gasboom.
- d) Connect the other end of power control cables to the pyro controller (9-60V external trigger source), such as SHOWVEN PyroSlave X16.
- e) Connect machine with E-stop terminal or E-Stopper.
- f) Power on all uFlamer Gasboom
- g) Set the Ext Ignite to ON status in advanced interface, set the firing duration.

**6. Power ON the DMX console/Pyro controller and programming**

Power on DMX console and program the uFlamer Gasboom effect on DMX console

**7. Test the ignition function of uFlamer Gasboom**

Test the ignition function of uFlamer, we can check whether the igniters of each unit of uFlamer is working fine. Due to the safety switch is stay at TEST MODE there will be only ignition while jet solenoid valve is not open, so no flames generated.

**8. Firing**

- a) Double confirm the prescribed safety isolation zone is clear, no person, animal or other property within this region.
- b) Switch the safety button of uFlamer Gasboom to USER MODE.



- c) Firing, the operator should always have a clear view of the device, so that he/she can stop the show immediately when there is danger.

**9. Power OFF and close the shut-off valve**

- a) Power OFF DMX console
- b) Press E-Stopper to power OFF all machine
- c) Close the shut-off valve for each machine

**10. Empty the remaining fuels and package machine**

- a) Release the E-Stopper allow machine to be power on again, firing machine several times until no flame is being generated
- b) Switch safety switch of uFlamer Gasboom to TEST MODE
- c) Power OFF uFlamer Gasboom
- d) Unplug power cable, DMX cable, E-Stopper connection cable etc.
- e) Package the machine when it is cool down

**▲ Nozzles and Nozzle Replacement**

**1. Nozzles**

There are four types of Nozzle for uFlamer Gasboom. G16, G20 (standard configuration), G25, GA. The related firing height and safety distance please check previous content of this manual.





**WARNING:** Forbid to operate uFlamer Gasboom without nozzle, it will cause accidental flame.

**WARNING:** According to the site environment and condition, please choose appropriate type of nozzle.

**DANGER:** Do NOT use parts or components which are not originally from SHOWVEN.

**NOTICE:** When the device is placed or transported without packaging, please use adhesive tape to cover the nozzle to prevent foreign matter from entering.

## 2. Fuel Consumption

Below testing result is based on two 450g gas cartridges as show in above picture, and firing duration is 0.2s, environment temperature is 30°C.

Nozzle type	G16	G20	G25	GA
0.2s flame ball quantity	Approx. 350	Approx. 270	Approx. 200	Approx. 110

## 3. Nozzle Replacement

Use 19mm outer hexagon socket wrench (RMHDT120) to disassemble the nozzle, clean the nozzle and nozzle socket with air gun (air compressor), change a different nozzle and install it.



**WARNING:** Do unplug the power cable when service flamer.

## △ Igniter Position Adjustment

Whenever changed the nozzle or ignition is not good, please check igniter pole position according to below parameters. The right position for each pair of pole should have a gap from tip to tip of  $3.5 \pm 0.5$ mm and a gap between two igniter of  $52 \pm 1$ mm. Check the ignition success rate after adjustment by firing.

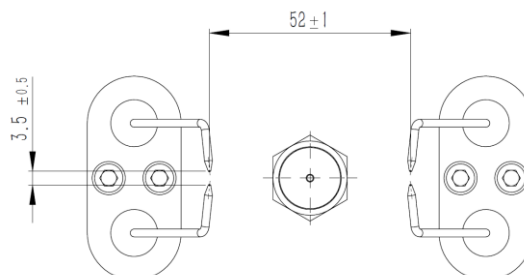

## ▲ Maintenance

1. To maintain the machine in good performance and running status, it is recommended to running the device at least once per month.
2. Check the ignition probes both before and after each show, if there is any foreign objects on it please clean it up.
3. Shut-off valve maintenance: make sure no impurities in the gas cartridge and cartridge holder connection part. If the machine not use for a long time, it is recommended to use tape to seal this part and store it.
4. Maintenance of the nozzle: Nozzle needs to be cleaned from time to time, and it is recommended that once every six months (depending on the environment and frequency of use). In the process of using the equipment, if the flame shape is seriously deformed or the fuel injection line is significantly deformed or coarsened, the nozzle should be removed immediately for cleaning. If after clean, there are still problems please replace new nozzle.
5. Maintenance of the O-ring: If it is found that the O-ring of the nozzle is damaged or ageing when cleaning the nozzle, the O-ring should be replaced in time (material and size of O-ring: fluorine rubber O-ring, the outermost diameter is 14 mm, and the line diameter is 2 mm).

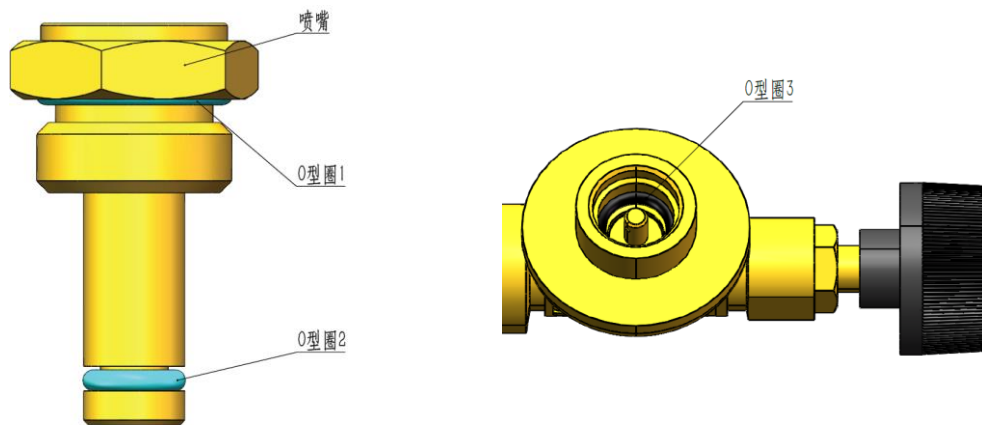

O ring 1: Inner diameter 13.2mm X wire diameter 1.8mm

O ring 2: Inner diameter 5.15mm X wire diameter 1.8mm

O ring 3: Inner diameter 8.0mm X wire diameter 2mm

6. Flame detector maintenance: Recommended to clean the carbon buildup on flame detector at least once per month (depending on the use environment and frequency), if the detector is found to be insensitive, clean it immediately.

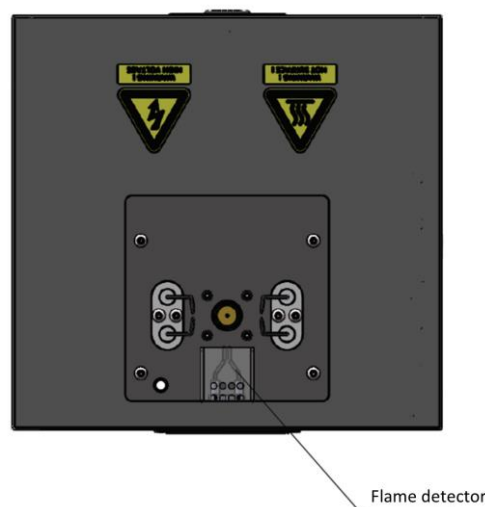

**▲ Optional Parts for uFlamer Gasboom**

Part. No.	Description	pcs / unit
RMWAS070	G1 O ring 13.2*1.8	1
RMWAS065	G1 O ring 5.15*1.8	
RMBOT036	Safety ring	1
RMMET045	Safety rope	1
RMEMD062	Wireless receiver ( for wireless control with FXcommander)	1
SFSMA012	Nozzle G20	1
SFSMA011	Nozzle G16	1
SFSMA013	Nozzle G25	1
SFSMA015	Nozzle GA	1
RMMET467	Cassette gas cartridge Adapter	2 or 4
SFMET1107	G1 E-Stop terminator	1
FPEST001	E-Stopper	1
RMHDT120	Nozzle disassemble tool 19mm	1
SFMET1136	hose, 5m	1
FPFLI042	2 in 1 flight case	1/2
SFCAB065	Waterproof DMX cable, 6m	1
SFCAB204	Waterproof DMX cable, 10m	1

### **▲ Warranty Instructions**

- ∨ Sincere thanks for your choosing our products, you will receive quality service from us
- ∨ The product warranty period is one year. If there are any quality problems within 7 days after shipping out from our factory, we can exchange a brand new same model machine for you
- ∨ We will offer free of charge maintenance service for machines which with hardware malfunction (except for the instrument damage caused by human factors) in warranty period. Please don't repair machine without factory permission

#### **Below situations NOT included in warranty service:**

- ∨ Damage caused by use unqualified fuels;
- ∨ Damage caused by improper transportation, usage, management, and maintenance, or damage caused by human factors;
- ∨ Disassemble, modify or repair products without permission;
- ∨ Damage caused by external reasons (lightning strike, power supply etc.)
- ∨ Damage caused by improper installation or use;

For product damage not included in warranty range, we can provide paid service.

Invoice is necessary when applying for maintenance service from SHOWVEN

# SHOWVEN<sup>®</sup>



**Showven Technologies Co., Ltd.**

Tel: +86-731-83833068

Web: [www.showven.cn](http://www.showven.cn) E-mail: [info@showven.cn](mailto:info@showven.cn)

Add: Liuyang Economic Development Zone, Changsha, 410300, Hunan Province,  
P.R.China